

## 70 Litre Pedal Bin

### Technical Specification:

- Unit Weight: 13.5KG
- Max Capacity: 70 Litre
- Dimensions: 830mm x 480mm x 380mm
- Colours:
  - White RAL9016
  - Yellow RAL1003
  - Green RAL6037
  - Brown RAL8014

### Key Safety Feature:

- Rear wheels for ease of movement
- Front opening panel to remove bag lifting, when emptying
- Fire retardant to:
  - Propagation of Flame: BS 476 part 6
  - Spread of Flame: BS 476 part 7
- Rubber pads to reduce noise when closing

### Maintenance & Operation:

- Bin has a capacity of 70 litres, do not over fill.
- Bin should not be used for the disposal of sharp objects etc.
- When depositing waste, ensure hand is removed from under lid before releasing foot pedal.
- When cleaning bin, ensure internal area is fully dry with no standing water present before returning to use.
- Bin should be removed from service if any element appears broken or is not working correctly.
- Bin should be placed a minimum of 3cm from wall to allow lid to fully open and close.
- Do not use strong corrosive chemical solvents to clean the product, which will damage the paint surface.
- Never dismantle, repair, modify, etc without permission.

## Instruction for Use:

Press foot pedal to open the lid. Do not lift lid with your hand:

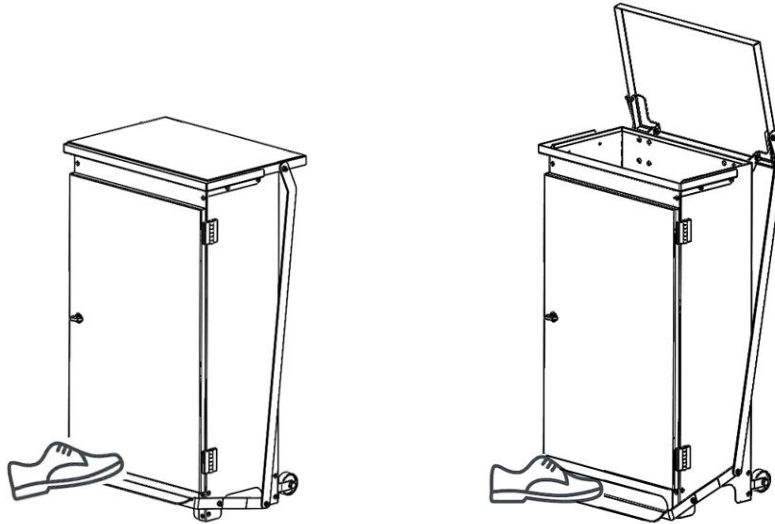

To remove a full bin bag, turn lock clockwise to open the front door, unfold excess bin bag over the top, pull bag down and out through door opening:

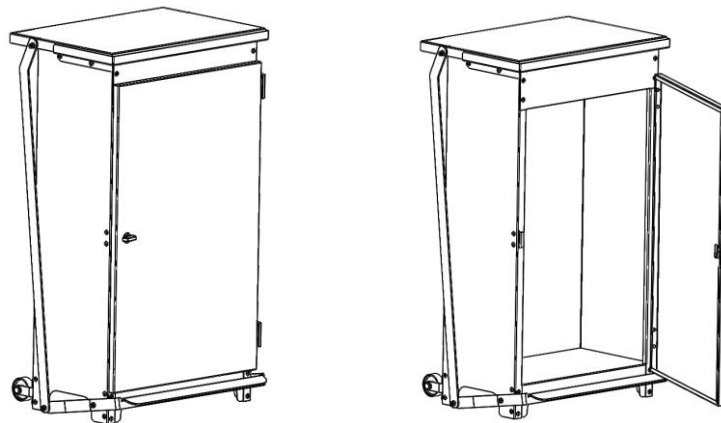

To move, tilt bin at an approx. 70° angle from the back until the wheels are free to move. Pull using the base of the lid, do not lift:

